

Product data sheet: B NLC D HB LI

Sensor for HubSense®

Bluetooth NLC sensor

For light harvesting and presence detection

D4I standard

Product family benefits

DiiA D4I certified incl.parts -351

Design freedom due to compact size

Easy to integrate in luminaire

Minimize internal wiring in combination with DEXAL drivers

Areas of application

Warehouse

Factories

Retails

Sports Hall

Benefits

With/without Daylight and Occupancy Sensor DEXAL Module

Bluetooth NLC

Control of D4I drivers or DALI drivers

Works with OSRAM Hubsense

Works with OSRAM DEXAL

Approval marks

CE, Bluetooth, D4I, SRRRC, UL

Housing material: plastic

Product Features

- Sensor for luminaire integration based on Bluetooth NLC
- IP grade 65*
- D4I controlled
- Stand by power consumption <150mW
- 50000 h lifetime at tc max = 60°C
- Installation height up to 17m
- IP grade 65*
- Wide detection range up to 18m
- Shield accessory
- 5 years guarantee
- UL

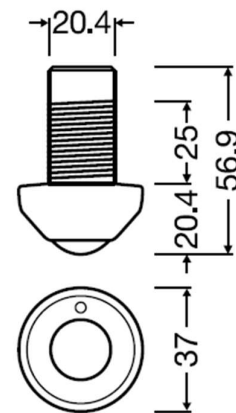

*IP65 is reached when used in combination with sealed accessory (i.e. the mount batten adapter)

Electrical Specifications

	Item	Value	Unit	Remarks
INPUT/OUTPUT	Rated voltage	12 – 22.5	Vdc	According to D4I standard
	Average input current	10	mA	
	Peak input current	30	mA	
	System wattage	<150	mW	System assumption (0.37W driver + 0.12W dongle)
	Radio frequency	2.4	GHz	
	Max Tx Power	+8	dBm	4.884 mW
	Wireless protocol			Bluetooth NLC provided by SILVAIR
	Range	20	m	Line of sight
CAPABILITIES	Control	D4I		DALI parts: 101, 103, 351
	Number of connected drivers	4		D4I LED drivers
	Type of sensor			PIR and Light sensor
	Detection angle	+/-20°		50% lux detection
	Mounting heights	8 – 17	m	Minimum – Maximum height
	Min temperature difference between the target and the surroundings	up to 17m up to 12m	4°C 2°C	
	Installations			In Luminaire
	PIR detection range	18	m	
	Detection angle	360	°	
	Light measurement	5-1000	lux	lux with daylight harvesting function (β-angle 40°: ±20°),
	Reset			Magnet
LEDs indicator			Blue x 1, Red x 1 (pairing, connected & etc. indications)	
ENVIRONMENT	Ambient temperature range t_a	-20 ...+50	°C	
	Maximum case temperature t_c	60	°C	(50,000 hrs lifetime at max. $T_a = 50°C / T_c = 60°C$)
	Max. case temp. in fault condition	110	°C	
	Storage temperature range	-20 ...+70	°C	
	Operating humidity	0 ... 90	%	
	Storage humidity	0 ... 95	%	Not condensing
	Environmental rating	Indoor		
	IP rating	IP 65		When installed on sealed device with gasket
DIMENSIONS AND WEIGHT	Expected lifetime	50'000	h	$T_a=50°C$ or $T_c=60°C$
	Screw thread length	25	mm	
	Length	56.9	mm	
	Diameter internal	21.8	mm	
	Diameter external	37	mm	
	Protusion	20.4	mm	With PIR 18 mm
	Mounting hole diameter	22.2 – 23.2	mm	
	Product weight	21	g	
	Wire preparation length, input side	7 ... 9	mm	
	Cable cross section, input side	0.25...0.75	mm ²	
Maximum allowed cable length	10	m		
STANDARDS	CE LVD: EN61347-2-11 EMC: EN 301 489-1 EN 301 489-17 EN 50581 EN 62479 EN 300 328 DALI 2: EN IEC 62386-101, EN IEC 62386-103 and D4i Part 351 RoHS & REACH compliance UL SRRC			

Detection range

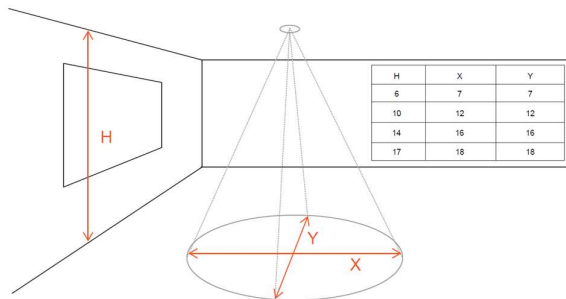

H	X	Y
6	7	7
10	12	12
14	16	16
17	18	18

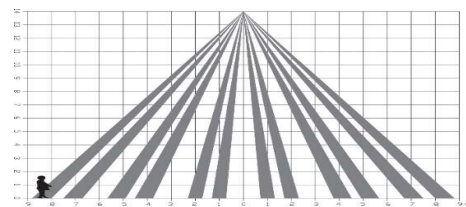
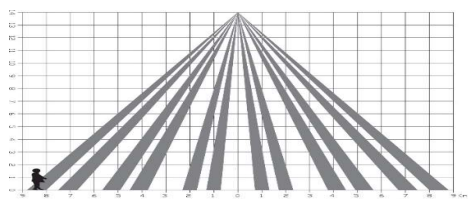
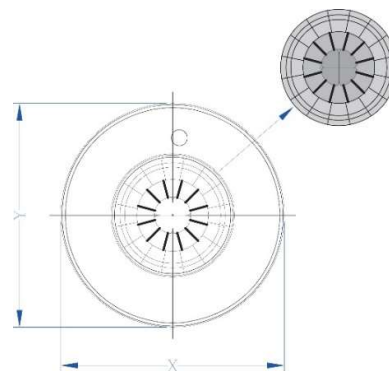
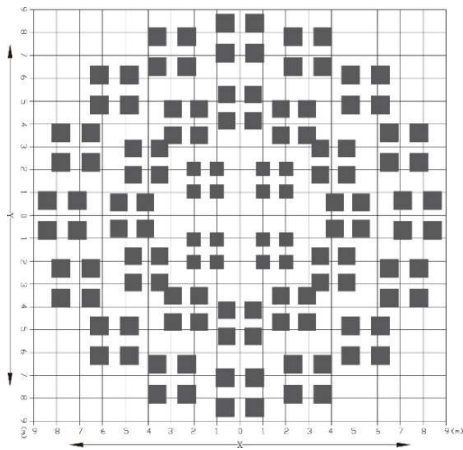
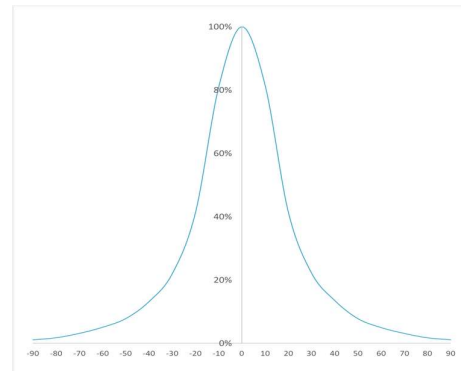

Installation Tips

Do not install the sensor directly next to a window which can cause incorrect measurement of the natural light. Keep minimum distance as per table below

Height	Distance from window
10 m	6 m
14 m	8,4 m
17 m	10 m

Do not calibrate the sensor in low level of light. It can cause incorrect calibration when setting Lux value.

Light sensor accuracy may depend on the surface reflectance

Additional product information

- By integrating the device into a casing, the wireless range could be affected by metal surfaces. Therefore, the wireless range needs to be verified after integration.
- The device could be reset to factory default by magnet (cfr User Instruction)
- The status LED of the device indicates following Network status
 - Blue LED Indicator:
 - Success connection: LED indicator flashes 2s at once
 - No connections: LED indicator flashes 0.3s at once
 - Reset to factory settings:
 - LED indicator flashes 1s at once, then quickly flashes and disappears
 - Red LED Indicator:
 - Warm up: LED indicator disappears after 60s
 - When PIR is triggered, the LED indicator quickly flashes at once; continuous triggered, LED indicator flashes every 1s at once
- The device has passed successfully the SILVAIR Testing process.
- The device can be put into operation using the OSRAM HubSense Commissioning Tool (<https://platform.hubsense.eu>), subject to prior acceptance of the Terms of Use and the Privacy Policy.
- OSRAM may terminate or suspend the use of the HubSense Commissioning Tool at any time and for any or no reason in its sole discretion, even if access and use is continued to be allowed to others.
- The device complies with Bluetooth mesh Standard v1.0. It can also be used in 3rd party Bluetooth mesh network, that complies with this standard and that supports the mesh models of this device, and with certain 3rd party commissioning tools, that support the mesh models of this device. In order to ensure correct interoperability a verification with the 3rd party network components and the 3rd party commissioning tool is necessary in advance. Please contact OSRAM (support@hubsense.eu) to receive the actual list of supported models for this device.
- OSRAM shall have no liability for any 3rd party commissioning tool and does not make any representations, express or implied, about the availability and/or performance of such commissioning tool.
- OSRAM shall have no liability for and does not make any representations, express or implied, about the connectivity of OSRAM qualified Bluetooth mesh products with any other products, that have passed the SILVAIR Testing process

ordering information

Product type	EAN10
B NLC D HB LI	6977078990363

Inventronics GmbH
 Parkring 31-33, 85748 Garching,
 Germany
 Email:
support@inventronicsglobal.com